

Electric motors

DC motors of 1GDC Series

Powerful, efficient and flexible...

Technical catalogue





DC motors for all types of industry



Quality management and certificates

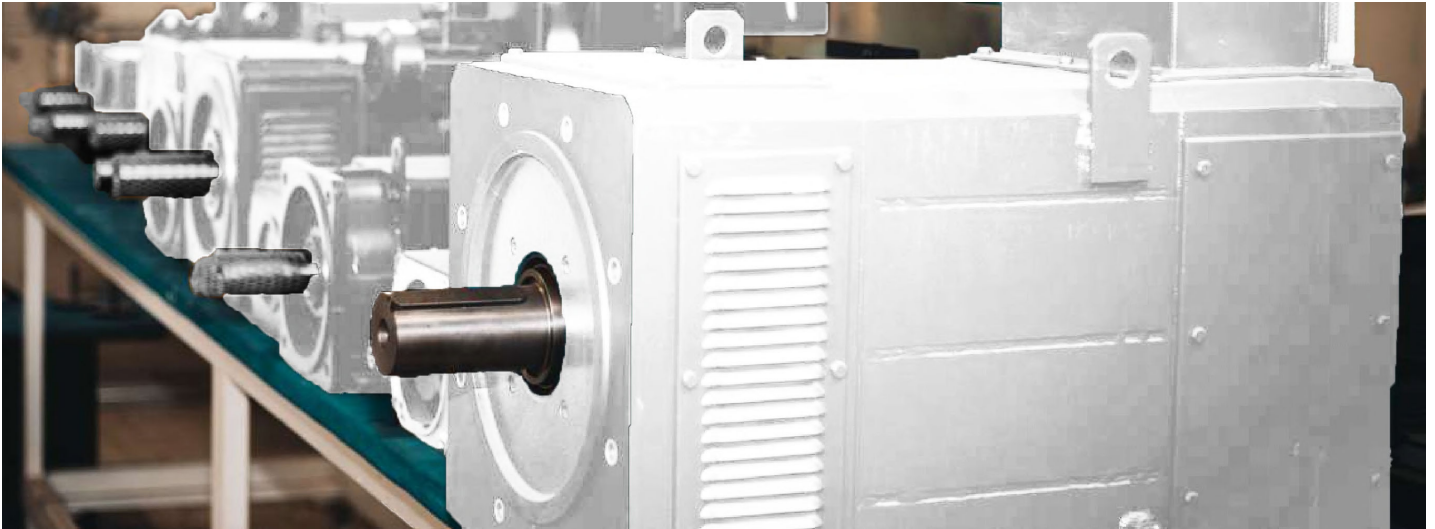

VYBO Electric is a modern High-tech energy saving company that pays high attention to quality, environment, safety and precision and efficiency of work and energy in production. Therefore, it holds a lot of certificates and quality control systems. **Our priority is quality control.**

Basic certificates include:

ISO9001

The primary task of the ISO 9001 standard is to focus on system management and quality management in the organization. The satisfaction of the customer and the fulfillment of his requirements, which are specified in contracts, orders, or technical drawings, are in the first place. The quality management system is linked to all processes in the company. The standard focuses on the management of human and financial resources, on the stability of infrastructure, including buildings, transport, hardware, software and other communication or information technologies. An important part is also the planning of production and services, the management of the purchasing process, but also the management of non-conforming products.



ISO14001

The main priority of the ISO 14001 standard is to identify and understand the environmental aspects and activities that are related to the entire infrastructure of the company and, based on this, to regulate the environmental impact on the environment.

In its scope, the ISO 14001 standard creates the conditions for determining environmental goals and plans, the fulfillment of which is examined at regular intervals by top management and also by an independent body during internal audits.

This standard is intended for all organizations and companies that consider environmental protection as their primary goal.

The benefit of the standard for society is mainly:

- control over the environmental impact on the environment
- control over produced emissions and waste
- saving material and energy
- prevention of accidents
- compliance of the company's activities with legal requirements
- zero fines for environmental behavior
- creation of a good reputation and prestige of the company



The ISO 45001

Specification (formerly known as OHSAS 18001) is an internationally recognized standard that declares compliance with the principles of a safe enterprise, managing risks at work and protecting the health of workers during work. It does not only concern danger and accidents, but also emphasizes other aspects such as the good condition and mental well-being of the employee.

The certificate is held in Slovakia as STN ISO 45001:2019 and is under the title Management systems of safety and health protection at work. Requirements with guidance for use. It replaces the STN OHSAS 18001 standard.



ISO 50001

Energy management systems Energy efficiency help organizations save money, save energy resources and also help to prevent climate change. ISO 50001 encourages organizations in all sectors to use energy more efficiently through the development of an energy management system. The international standard ISO 50001: 2011 specifies the requirements for building, maintaining and improving the energy system. It aims to enable organizations to implement a systematic approach that will help achieve lasting improvements in energy efficiency, energy use and consumption.



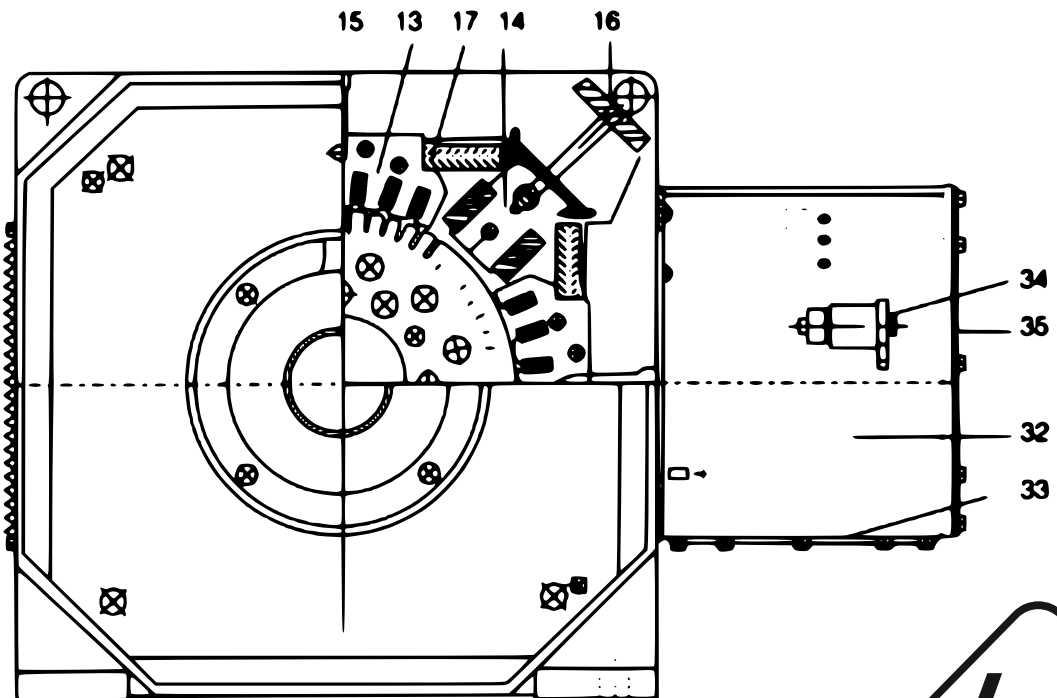
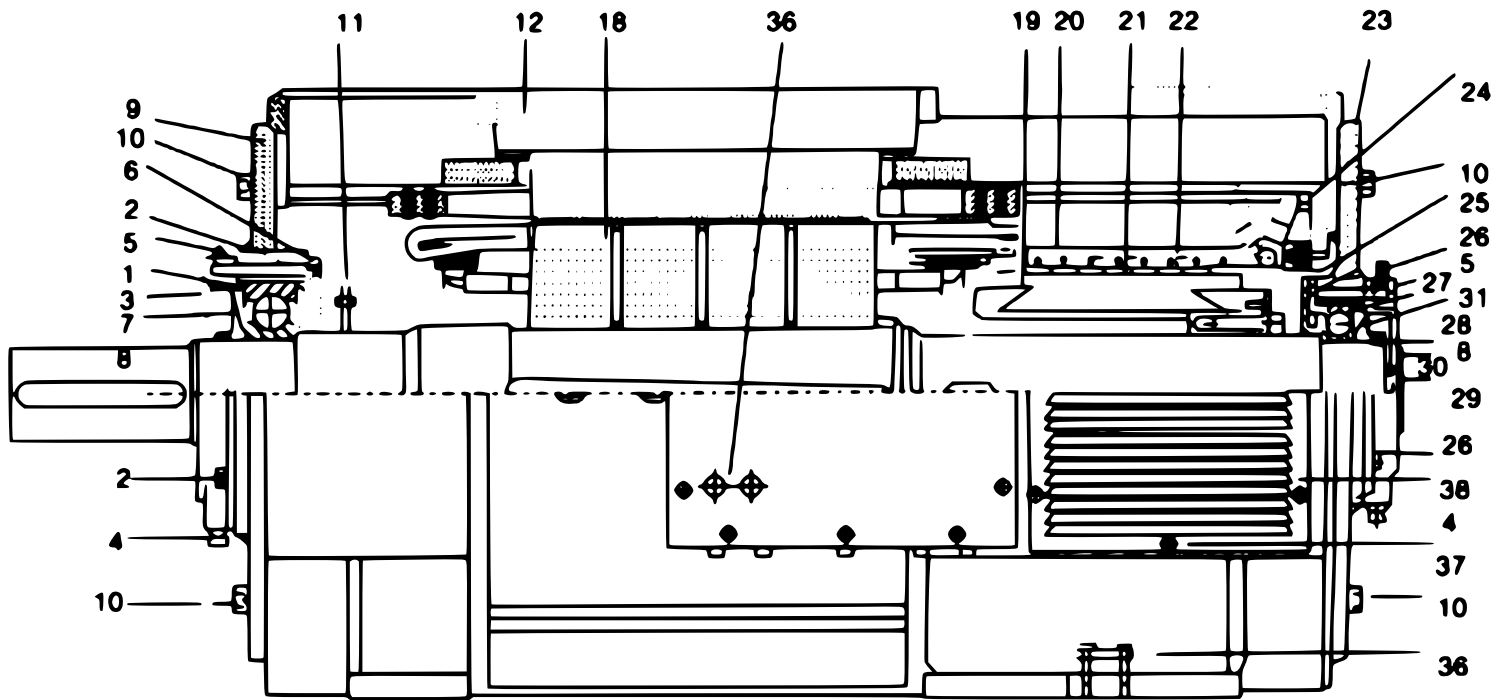

1. Ball bearing AS*
2. Screw of bearing cover AS
3. Bearing cover AS outer
4. Oil-cap of ball bearing AS&NS**
5. Oil nipple AS&NS**
6. Bearing cover AS inner
7. Centrifugal disc AS
8. Headless screw for centrifugal disc AS&NS
9. End shield AS
10. Fastening screw of end shield AS&NS
11. Balancing disc AS
12. Frame
13. Main pole
14. Compole
15. Screw of main pole
16. Screw of compole
17. Compensating winding
18. Armature
19. Commutator
20. Brush rocker
21. Brush holder
22. Carbon brush
23. End shield NS
24. Fastening screw with washer
25. Bearing over NS5 inner
26. Screw of bearing cover NS
27. Bearing cover NS outer
28. Centrifugal disc NS
29. Endplate
30. Screw of endplate
31. Ball bearing NS
32. Terminal box
33. Outlet plate with gasket-sealing
34. Terminal
35. Terminal box lid
36. Grounding bolt
37. Screw of louvre NS
38. Louvre NS

Note:

*AS: Drive side

**NS: Non-drive side



Technical data for 1GDC

Frame reference and size	Rated power	Full load speed in revolutions per minute			Speed with field weakened	Arm. current	Field power	Arm. circuit resistance	Arm. circuit resistance	Field inductance	smooreins induct.	Efficiency	Moment of inertia	Weight
		160V	400V	440V										
Type	Power kW	160V	400V	440V	Speed r/min	LN	PF	R (Ω (20°C))	R mH	LF H	LR mH	η (%)	GD ² kg*m ²	Weight kg
1GDC-100-1	2.2	1490			3000	17.9	31.5	1.19	11.2	22	15	67.8	0.044	72
	1.5	955			2000	13.3		2.17	21.4	13	15	58.5		
	4		2630		4000	12		2.82	26	18		78.9		
	4			2960	4000	10.7						80.1		
	2		1310		3000	6.6		9.12	86	18		68.4		
	2.2			1480	3000	6.5						70.6		
	1.4		860		2000	5.1		16.76	163	18		60.3		
	1.5			990	2000	4.77						63.2		
1GDC-112/2-1	3	1540			3000	24	320	0.785	7.1	14	20	69.1	0.072	100
	2.2	975			2000	19.6		1.498	14.1	13	20	62.1		
	5.5		2630		4000	16.4		1.933	17.9	17		79.9		
	5.5			2940	4000	14.7						81.1		
	2.8		1340		3000	9.1		6	59	17		71.2		
	3			1500	3000	8.6						72.8		
	1.9		855		2000	6.9		11.67	110	13		61.1		
	2.2			965	2000	7.1						63.5		
1GDC-112/2-2	4	1450			3000	31.3	350	0.567	6.2	14	12	72.6	0.088	107
	3	1070			2000	24.8		0.934	10.3	14	10	66.8		
	7		2660		4000	20.4		1.305	14	19		82.4		
	7.5			2980	4000	19.7						83.5		
	3.7		1320		3000	11.7		4.24	48.5	19		74.1		
	4			1500	3000	11.2						76		
	2.6		895		2000	9		7.62	83	14		65.1		
	3			1010	2000	9.1						67.3		
1GDC-112/4-1	5.5	1520			3000	42.5	500	0.38	3.85	6.8	6.5	73	0.128	106
	4	990			2000	33.7		0.741	7.7	6.7	4.5	64.9		
	10		2680		3500	29		0.89	9	6.8		82.7		
	11			2950	3500	28.8						83.3		
	5		1340		1800	15.7		3.01	30.5	6.8		74.3		
	5.5			1480	1800	15.4						75.7		
	3.7		855		1100	13		5.78	60	6.7		65.2		
	4			980	1100	12.2						68.7		
1GDC-112/4-2	5.5	1090			2000	43.5	570	0.441	5.1	7.8	6	69.5	0.156	114
	13		2740		3600	37		0.574	6.4	5.8		84.4		
	15			3035	3600	38.6						85.4		
	6.7		1330		1800	20.6		2.12	24.1	7.8		76.8		
	7.5			1480	1800	20.6						78.4		
	5	955			1200	16.1		3.46	40.5	5.8		71.1		
	5.5			1025	1200	15.7						71.9		



Technical data for 1GDC

Frame reference and size	Rated power	Full load speed in revolutions per minute		Speed with field weakened	Arm. current	Field power	Arm. circuit resistance	Arm. circuit resistance	Field inductance	Efficiency	Moment of inertia	Weight	
		400V	440V										NF
Type	kW	r/min		r/min	A	W	(Ω (20°C))	mH	H	(%)	kg·m ²	kg	
1GDC-132-1	18.5	2610		4000	52.2	650	0.368	5.3	6.5	85	0.32	140	
	18.5	2850		4000	47.1					85.9			
	10	1330		2100	30.1		1.309	18.9	8.9	79.4			
	11	1480		2200	29.6		2.56	37.5	6.3	80.9			
	7	865		1600	22.7					71.9			
	7.5	975		1600	21.4					74.5			
20	2800		3600	55.4	730	0.226				3.65	10	87.8	
22	3090		3600	55.3			88.3						
15	1360		2500	44.5		0.811	13.5	7.7	81.2				
15	1510		2500	39.5		1.565	26	6	83.4				
10	905		1400	31.1					75.6				
11	995		1400	30.5					77.7				
27	2720		3600	74.5	800				0.1905	3.4	21	88.2	
30	3000		3600	75		88.6							
18.5	1390		2100	53.2		0.531	9.8	6.6	83.6				
18.5	1540		2200	47.6		0.976	19.4	6.5	84.7				
13.5	945		1600	40.5					79.4				
15	1050		1600	40.5					80.5				
33	2710		3500	93.4	820				0.1835	3.15	10	87.4	
37	3000		3500	93.4		88.5							
19.5	1350		3000	58.8		0.593	10.4	7.7	80.4				
22	1500		3000	58.8		82.6							
1GDC-160-	22	40.5		2710	3500	113	920	0.1426	2.7	10	88.2	0.76	242
	45	3000		3500	113	89.1							
	21	16.5		900	2000	50.5		0.862	17.7	6	77.9		
	18.5	1000		2000	50.5	79.4							
1GDC-160-	32	49.5		2710	3500	137	1050	0.097	2.07	11	89.1	0.88	268
	55	3010		3500	137	90.2							
	31	27		1350	3000	77.8		0.376	8.3	10	84.7		
	30	1500		3000	77.8	0.675		15.2	6.3	85.7			
	31	19.5		900	2000					59.1	79.1		
	22	1000		2000	59.1					81.7			
33	1350		3000	95.4	1200		0.29			5.8	7.1	84.7	
37	1500		3000	95.4		86.5							
16.5	670		1900	51.4		0.947	17.6	5.6	75.5				
18.5	750		1900	51.4		1.264	25	5.6	78.1				
13	540		1400	42.4					73				
15	600		1400	42.4					74.1				



Technical data for 1GDC

Frame reference and size	Rated power	Full load speed in revolutions per minute		Speed with field weakened	Arm. current	Field power	Arm. circuit resistance	Arm. circuit resistance	Field inductance	Efficiency	Moment of inertia	Weight
		400V	440V									
Type	kW	r/min		r/min	A	W	(Ω [20°C])	mH	H	(%)	kg*m ²	kg
1GDC-180-	22	67	2710	3400	185	1400	0.0555	1.16	6.9	89.5	1.72	350
		75	3000							90.7		
	21	40.5	1350	2800	115		0.2125	4.65	6.6	85.8		
		45	1500							87		
	21	27	900	2000	79		0.419	9.3	7.3	82.2		
		30	1000							83.7		
	21	19.5	670	1400	61		0.756	15.7	7.1	77.3		
		22	750							79.7		
	21	16.5	540	1600	52		1.003	21.9	5	73.8		
		18.5	600							76.8		
1GDC-180-31	33	900	2000	97	1500	0.332	7.7	6.6	82.8	1.92	380	
		37							1000			83.6
	19.5	540	1250	62		0.801	19	6.6	74.8			
	22	600							76.6			
1GDC-180-	42	81	2710	3200	221	1700	0.051	1.16	12	91	2.2	410
		90	3000						91.3			
	41	50	1350	3000	139		0.1417	3.2	5.7	87.5		
		55	1500							87.7		
	41	27	670	2000	80		0.454	10.4	6.3	80.4		
		30	750							81.1		
1GDC-200-	12	99	2710	3000	271	1400	0.0373	0.83	7.62	90.2	3.68	485
		110	3000						91.6			
	11	40.5	900	2000	118		0.2653	8.4	7.01	83.4		
		45	1000							85.5		
	11	33	670	1600	99		0.369	10.6	7.77	80.2		
		37	750							82.9		
	11	19.5	450	1000	64		0.93	21.9	7.3	72.2		
		22	500							77.4		
1GDC-200-	21	67	1350	3000	188	1500	0.0885	2.8	6.78	88.7	4.2	530
		75	1500						89.6			
	21	27	540	1000	82		0.535	14	9.64	78.8		
		30	600							80.4		
1GDC-200-	32	119	2710	3200	322	1750	0.0266	0.79	10.9	91.7	4.8	580
		132	3000						92.4			
	31	81	1350	2800	224		0.0771	2.6	5.61	88.7		
		90	1500							90		
	31	49.5	900	2000	141		0.1751	4.8	8.54	85.6		
		55	1000							87.1		
	31	40.5	670	1400	119		0.283	8.5	8.35	82.5		
		45	750							84.1		
	31	33	540	1200	101		0.42	12.2	8.42	79.6		
		37	600							82		
	31	27	450	750	84		0.593	17.1	8.4	77.5		
		30	500							79.5		



Technical data for 1GDC

Frame reference and size	Rated power	Full load speed in revolutions per minute		Speed with field weakened	Arm. current	Field power	Arm. circuit resistance	Arm. circuit resistance	Field inductance	Efficiency	Moment of inertia	Weight
		400V	440V									
Type	kW	r/min		r/min	A	W	(Ω [20°C])	mH	H	(%)	kg·m ²	kg
1GDC-225-11	99	1360		3000	276	2300	0.0664	2.1	4.45	87.9	5	680
	110	1500								89.4		
	67	900		2000	193		0.1406	4.9	4.28	84.4		
	75	1000					86.5					
	49	680		1300	146		0.2433	8.7	5.77	81.2		
	55	750					84					
	40	540		1200	123		0.356	9.5	6.38	78.2		
	45	600					80.8					
	33	450		1000	103		0.476	15.2	6.10	76.5		
	37	500					78.8					
1GDC-225-21	49	540		1000	148	2470	0.2648	9.5	4.14	79.3	5.6	740
	55	600					82.4					
	40	450		1000	125		0.397	13.7	5.41	76.6		
	45	500					78.9					
1GDC-225-31	119	1360		2400	327	2580	0.0454	1.5	5.33	89.3	6.2	800
	132	1500								90.5		
	81	900		2000	227		0.093	3.4	5.3	86.9		
	90	1000					88					
	67	680		2250	197		0.167	5.1	5.44	82.5		
	75	750					85.1					
1GDC-250-	12	1360		2100	399	2500	0.0444	1.3	4.29	88.8	8.8	890
	160	1500								89.9		
	99	900		2000	281		0.0911	2.4	4.55	86.2		
	110	1000					88.1					
1GDC-250-21	167	1360		2200	459	2750	0.0325	0.91	4.28	89.8	10	970
	185	1500								90.5		
	81	680		2250	234		0.1306	3.9	5.41	83.2		
	90	750					85.2					
1GDC-250-31	180	1360		2400	493	2850	0.1281	0.87	5.32	90.4	11.2	1070
	200	1500								91.5		
	119	900		2000	334		0.0668	1.7	5.46	87.4		
	132	1000					89.1					
	67	540		2000	204		0.202	4.0	4.0	80.8		
	75	600					84.6					
	49	450		1200	152		0.305	7.3	5.1	78.5		
	55	500					82.4					



Technical data for 1GDC

Frame reference and size	Rated power	Full load speed in revolutions per minute		Speed with field weakened	Arm. current	Field power	Arm. circuit resistance	Arm. circuit resistance	Field inductance	Efficiency	Moment of inertia	Weight	
		400V	440V										NF
Type	kW	r/min		r/min	A	W	(Ω [20°C])	mH	H	(%)	kg·m ²	kg	
1GDC-250-	41	198	1360	2400	539	3000	0.0237	0.93	6.19	91	12.8	1180	
		220	1500							91.7			
	42	144	900	2000	401		0.0485	1.9	4.63	88.11			
		160	1000							89.2			
		41	99	680	1900		283	0.0102	2.6	5.3			85.8
			110	750									87.4
	41	81	540	1600	236	0.141	4.7	6.36	83.4				
		90	600						85				
	41	67	450	1800	201	0.195	5.1	4.97	80				
		75	500						83.4				
1GDC-280-11	226	1355	2000	614	3100	0.02134	0.69	4.58	90.9	16.4	1280		
		250							1500			91.6	
1GDC-280-	22	253	1355	1800	684	3500	0.01796	0.77	5.3	91.5	18.4	1400	
		280	1500							92.1			
	21	180	900	2000	498		0.0373	1.2	4.46	89.1			
		200	1000							90.1			
		21	119	675	1600		333	0.0662	2.3	4.37			87.1
			132	750									88.6
	21	99	540	1500	281	0.093	3.1	4.57	84.7				
		110	600						86				
1GDC-280-	32	284	1360	1800	768	3600	0.01493	0.59	6.94	91.7	21.2	1550	
		315	1500							92.6			
	31	198	900	2000	545		0.0314	1.1	5.54	89.7			
		220	1000							90.6			
		32	144	675	1700		402	0.0532	2	5.47			87.8
			160	750									89.1
	31	118	540	1000	339	0.0839	2.6	5.77	85.4				
		132	600						86.8				
	31	80	450	1400	234	0.1377	5.3	9.03	84.1				
		90	500						85.4				
1GDC-280-	42	225	900	1800	616	4000	3.02545	0.96	5.29	90.2	24	1700	
		250	1000							91.1			
	41	166	675	1900	464		0.0457	1.7	5.19	88.1			
		185	750							89.4			
		41	98	450	1000		282	0.0993	3.7	6.86			85.1
			110	500									86.9



Technical data 1GDC

Frame reference and size	Rated power	Full load speed in revolutions per minute		Speed with field weakened	Arm. current	Field power	Arm. circuit resistance	Arm. circuit resistance	Field inductance	Efficiency	Moment of inertia	Weight
		400V	440V									
Type	kW	r/min		r/min	A	W	(Ω [20°C])	mH	H	(%)	kg*m ²	kg
1GDC-315-12	321	1360		1800	865	3850	0.015	0.39	8.64	92.2	21.2	1890
	355	1500								92.8		
	253	900		1600	690		0.2355	0.46	5.06	90.4		
	280	1000					91.6					
	180	680		1900	500		0.04371	0.83	4.97	88.4		
	200	750					89.4					
1GDC-315-11	144	540		1900	409	4350	0.06919	1.3	7.6	86.4	24	2080
	160	600								87.4		
	118	450		1600	344		0.1	2.3	9.43	84.4		
	132	500					86.3					
	98	360		1200	294		0.1415	2.9	9.96	81.7		
	110	400					84.3					
1GDC-315-22	284	900		1600	772	4350	0.02034	0.49	5.91	91	24	2080
	315	1000								91.5		
	225	680		1600	624		0.03392	0.74	18.8	88.7		
	250	750					89.6					
1GDC-315-21	166	540		1600	468	4350	0.05382	1.2	25	87.2	24	2080
	185	600								88.5		
	143	450		1500	413		0.076	1.5	19	84.7		
	190	500					86					
1GDC-315-32	320	900		1600	867	4650	0.01658	0.39	23.1	91.0	27.2	2290
	355	1000								92.0		
	252	680		1600	697		0.03043	0.82	21.5	89.1		
	280	750					89.8					
	180	540		1500	501		0.04536	0.95	31.6	88.2		
200	600		89.4									
1GDC-315-31	118	360		1200	344	4650	0.1002	2.1	23.3	83.2	30.8	2520
	132	400								85.3		
1GDC-315-42	361	900		1400	971	5200	0.01302	0.33	29	92.1	30.8	2520
	400	1000								92.7		
	284	680		1600	778		0.02364	0.67	20.8	90		
	315	750					90.7					
	225	540		1600	626		0.03554	0.87	21.9	88.3		
250	600		89									
1GDC-315-41	166	450		1500	468	5200	0.055	1.4	37.4	87.3	30.8	2520
	185	500								88.3		
	143	360		1200	416		0.0803	1.8	22.2	84		
	160	400					85.3					



Technical data for 1GDC

Frame reference and size	Rated power	Full load speed in revolutions per minute		Speed with field weakened	Arm. current	Field power	Arm. circuit resistance	Arm. circuit resistance	Field inductance	Efficiency	Moment of inertia	Weight				
		400V	440V										NF	LN	PF	R
Type	kW	r/min		r/min	A	W	(Ω (20°C))	mH	H	(%)	kg*m ²	kg				
1GDC-400-	22	435	680	1400	1175	5700	0.0139	0.33	7.385	90,8	74	4500				
		480	750							92						
	21	235	360	1200	675		0.0497	1	7.3	84,8						
		260	400							86,3						
	21	180	270	900	537		0.0804	1.6	7.44	81,8						
		200	300							83,1						
1GDC-400-	32	500	680	1400	1340	6400	0.0112	0.3	9.57	91,2	84	4900				
		550	750							92,5						
	32	400	540	1300	1083		0.0162	0.35	4.51	89,9						
		440	600							91,9						
	32	344	450	1300	952		0.0248	0.58	6	88,1						
		380	500							89,5						
	31	270	360	1200	768		0.03821	0.82	6.11	86						
		300	400							87,5						
	31	208	270	900	611		0.0659	1.5	5.89	82,8						
		230	300							84						
	1GDC-400-	42	435	540	1300		1175	7100	0.0134	0.32			5.54	90,8	94	5300
			480	600										92		
42		390	450	1400	1070	0.0201	0.47		6.86	88,6						
		430	500							90						
41		316	360	1200	880	0.0274	0.73		5.41	97,7						
		350	400							89						
41		235	270	900	676	0.0508	1.2		5.38	84						
		260	300							85,4						
1GDC-450-		22	472	540	1200	1286	6500		0.0133	0.29	10.2	90,8	138	5600		
			520	600								92,1				
	22	408	450	1400	1114	0.0159		0.41	7.99	90						
		450	500							91,3						
	22	362	360	1200	1010	0.0232		0.61	5.79	88,1						
		400	400							89,4						
	21	253	270	900	720	0.0415		1	5.82	85,8						
		280	300							87,1						



Technical data for 1GDC

Frame reference and size	Rated power	Full load speed in revolutions per minute		Speed with field weakened	Arm. current	Field power	Arm. circuit resistance	Arm. circuit resistance	Field inductance	Efficiency	Moment of inertia	Weight	
		400V	440V										
Type	Power kW	r/min		r/min	A	W	R (Ω (20°C))	LA mH	LF H	η (%)	GD ² kg*m ²	Weight kg	
1GDC-450-	32	500	540	600	1200	1385	0.0134	0.39	19.6	90.8	156	6000	
		550								92			
	32	453	450	500	1300	1228	0.0145	0.32	7.36	90			
		500								91.4			
	32	408	360	400	1200	1130	7100	0.0208	0.53	7.17			88.5
		450								89.7			
1GDC-450-	32	309	270	300	900	875	0.0342	0.83	4.8	85.9	174	6700	
		340								87.1			
	31	200	180	200	600	595	0.0751	1.9	9.09	81.3			
		220								82.6			
	42	545	540	600	1100	1492	0.0134	0.51	28.2	90.3			
		600								91.5			
1GDC-450-	42	500	450	500	1100	1367	0.0145	0.43	18.6	90	174	6700	
		550								91.4			
	42	453	360	400	1200	1254	7800	0.0178	0.42	5.85			88,9
		500								90			
	42	345	270	300	900	972	0.0275	0.81	5.62	86.8			
		380								88.1			
1GDC-450-	41	235	180	200	600	698	0.0612	1.7	5.73	81,7	174	6700	
		260								83			



Mounting and outline dimensions

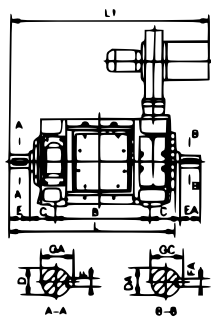

1GDC-100 - 1GDC-160

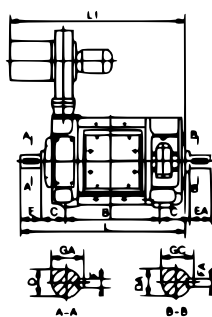

1GDC-180 - 1GDC-450

Type	Mounting dimensions													Outline dimensions						
	A	B	C	D	E	F	GA	DA	EA	FA	GC	H	K	AB	AC	AD	HD	L	L1	h1
1GDC-100-1	160	318	63	24	50	8	27	24	50	8	27	100	12	197	234	197	398	500	580	10
1GDC-100-2		358																540	620	
1GDC-112/2-1		337																544	612	
1GDC-112/2-2	190	367	70	28	60	8	31	28	60	8	31	112	12	221	255	202	452	574	642	10
1GDC-112/2-3		407																614	682	
1GDC-112/2-4		477																684	752	
1GDC-112/4-1		347																573	642	
1GDC-112/4-2	190	387	70	32	80	10	35	32	80	10	35	112	12	221	255	202	452	613	682	10
1GDC-112/4-3		437																663	732	
1GDC-112/4-4		497																723	792	
1GDC-132-1		355																619	814	
1GDC-132-2	216	405	89	38	80	10	41	38	80	10	41	132	12	260	295	240	527	669	964	12
1GDC-132-3		465																729	924	
1GDC-132-4		545																809	1004	
1GDC-160-11		411																744	953	
1GDC-160-12		476																809	986	
1GDC-160-21		451																784	993	
1GDC-160-22		516																849	1026	
1GDC-160-31	254	501	108	48	110	14	51.5	48	110	14	51.5	160	15	316	346	283	625	834	1043	14
1GDC-160-32		566																899	1076	
1GDC-160-41		561																894	1103	
1GDC-160-42		626																959	1136	
1GDC-160-51		631																964	1173	
1GDC-160-52		696																1029	1206	
1GDC-180-11		436																794	1022	
1GDC-180-12		501																859	1087	
1GDC-180-21		476																834	1062	
1GDC-180-22		541																899	1127	
1GDC-180-31	279	526	121	55	110	16	59	55	110	16	59	180	15	356	390	305	731	884	1112	16
1GDC-180-32		591																949	1177	
1GDC-180-41		586																944	1172	
1GDC-180-42		651																1009	1237	
1GDC-180-51		656																1014	1242	



Mounting and outline dimensions

Type	Mounting dimensions														Outline dimensions					
	A	B	C	D	E	F	GA	DA	EA	FA	GC	H	K	AB	AC	AD	HD	L	L1	h1
1GDC-200-11		566																977	1158	
1GDC-200-12		614																1025	1206	
1GDC-200-21		606																1017	1198	
1GDC-200-22	318	654	133	65	140	18	69	65	140	18	69	200	19	396	430	355	779	1065	1246	18
1GDC-200-31		686																1099	1278	
1GDC-200-32		734																1145	1326	
1GDC-200-41		756																1167	1348	
1GDC-200-42		804																1215	1396	
1GDC-225-11		701																1140	1605	
1GDC-225-12		761																1200	1665	
1GDC-225-21	356	751	149	75	140	20	79.5	75	140	20	79.5	225	19	440	474	398	981	1190	1655	20
1GDC-225-22		811																1250	1715	
1GDC-225-31		811																1250	1715	
1GDC-225-32		871																1310	1775	
1GDC-250-11		715																1225	1657	
1GDC-250-12		775																1285	1717	
1GDC-250-21		765																1275	1707	
1GDC-250-22	406	825	168	85	170	22	90	75	140	20	79.5	250	24	490	524	432	1031	1335	1767	25
1GDC-250-31		825																1335	1767	
1GDC-250-32		885																1395	1827	
1GDC-250-41		895																1405	1837	
1GDC-250-42		955																1465	1897	
1GDC-280-11		762																1375	1748	
1GDC-280-12		852																1405	1838	
1GDC-280-21		822																1375	1803	
1GDC-280-22		912																1465	1898	
1GDC-280-31	457	892	190	95	170	25	100	85	170	22	90	280	24	550	584	462	1130	1445	1878	25
1GDC-280-32		982																1535	1968	
1GDC-280-41		972																1525	1958	
1GDC-280-42		1062																1615	2048	
1GDC-280-51		1062																1615	2048	
1GDC-280-52		1152																1705	2138	
1GDC-315-091		817																1462	1827	
1GDC-315-092		907																1552	1917	
1GDC-315-11		887																1532	1897	
1GDC-315-12		977																1622	1987	
1GDC-315-21	508	967	216	100	210	28	106	95	170	25	100	315	28	620	654	497	1221	1612	1977	30
1GDC-315-22		1057																1702	2067	
1GDC-315-31		1057																1702	2067	
1GDC-315-32		1147																1792	2157	
1GDC-315-41		1157																1802	2067	
1GDC-315-42		1247																1892	2257	



Mounting and outline dimensions

Type	Mounting dimensions															Outline dimensions				
	A	B	C	D	E	F	GA	DA	EA	FA	GC	H	K	AB	AC	AD	HD	L	L1	h1
1GDC-355-081		818																1539	1860	
1GDC-355-082		908																1629	1956	
1GDC-355-091		888																1069	1930	
1GDC-355-092		978																1699	2020	
1GDC-355-11		968																1689	2010	
1GDC-355-12	610	1058	254	110	210	28	116	110	210	28	116	355	28	700	734	701	1301	1779	2100	30
1GDC-355-21		1058																1779	2100	
1GDC-355-22		1148																1869	2190	
1GDC-355-31		1158																1879	2200	
1GDC-355-32		1248																1969	2290	
1GDC-355-41		1268																1989	2310	
1GDC-355-42		1358																2079	2400	
1GDC-400-11		959																1732	1817	
1GDC-400-12		1079																1852	1937	
1GDC-400-21		1039																1812	1897	
1GDC-400-22	686	1159	280	120	210	32	127	120	210	32	127	400	35	790	830	750	1620	1932	2017	35
1GDC-400-31		1129																1902	1987	
1GDC-400-32		1249																2022	2107	
1GDC-400-41		1229																2002	2087	
1GDC-400-42		1349																2122	2207	
1GDC-450-11		1061																1944	2050	
1GDC-450-12		1181																2064	2070	
1GDC-450-21		1151		140	250	36	148											2034	2140	
1GDC-450-22		1271																2154	2260	
1GDC-450-31	800	1251	315					140	250	36	148	450	35	890	924	800	1720	2134	2240	40
1GDC-450-32		1371																2254	2360	
1GDC-450-41		1361																2294	2350	
1GDC-450-42		1481		160	300	40	169											2414	2470	
1GDC-450-51		1481																2414	2470	
1GDC-450-52		1601																2534	2590	



Mounting and outline dimensions

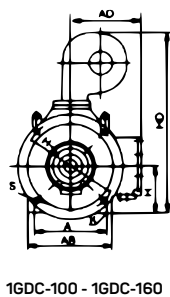
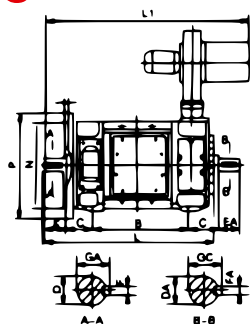

1GDC-100 - 1GDC-160

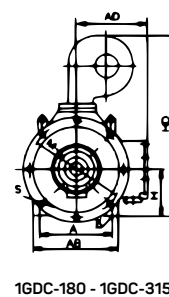
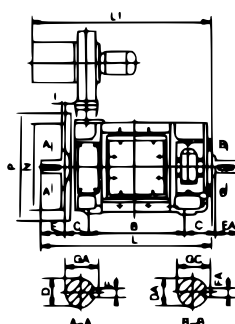

1GDC-180 - 1GDC-315

Type	Mounting dimensions															Outline dimensions									
	A	B	C	D	E	F	GA	DA	EA	FA	GC	H	K	M	N	S	Holes	T	P	AB	AC	AD	HD	L	L1
1GDC-100-1	160	318	63	24	50	8	27	24	50	8	27	100	12	215	180	15	4	4	250	197	234	179	398	500	580
1GDC-100-2		358																						540	620
1GDC-112/2-1		337																						544	612
1GDC-112/2-2	190	367	70	28	60	8	31	28	60	8	31	112	12	215	180	15	4	4	250	221	255	202	452	574	642
1GDC-112/2-3		407																						614	682
1GDC-112/2-4		477																						684	752
1GDC-112/4-1		347																						573	942
1GDC-112/4-2	190	387	70	32	80	10	35	32	80	10	35	112	12	215	180	15	4	4	250	221	255	202	452	613	682
1GDC-112/4-3		437																						663	732
1GDC-112/4-4		497																						723	792
1GDC-132-1		355																						619	814
1GDC-132-2	216	405	89	38	80	10	41	38	80	10	41	132	12	265	230	15	4	4	300	260	295	240	527	669	864
1GDC-132-3		465																						729	924
1GDC-132-4		545																						809	1004
1GDC-160-11		411																						744	953
1GDC-160-12		476																						809	986
1GDC-160-21		451																						784	993
1GDC-160-22		516																						849	1026
1GDC-160-31	254	501	108	48	110	14	51.5	48	110	14	51.5	160	15	300	250	19	4	5	350	316	346	283	625	834	1043
1GDC-160-32		566																						899	1076
1GDC-160-41		561																						894	1103
1GDC-160-42		626																						959	1136
1GDC-160-51		631																						964	1173
1GDC-160-52		696																						1029	1206
1GDC-180-11		436																						794	1022
1GDC-180-12		501																						859	1087
1GDC-180-21		476																						834	1062
1GDC-180-22		541																						899	1127
1GDC-180-31	279	526	121	55	110	16	59	55	110	16	59	180	15	250	300	19	4	5	400	356	390	304	731	884	1112
1GDC-180-32		591																						949	1177
1GDC-180-41		586																						944	1172
1GDC-180-42		651																						1009	1237
1GDC-180-51		656																						1014	1242
1GDC-180-52		721																						1079	1307



Mounting and outline dimensions

Type	Mounting dimensions																Outline dimensions								
	A	B	C	D	E	F	GA	DA	EA	FA	GC	H	K	M	N	S	Holes	T	P	AB	AC	AD	HD	L	L1
1GDC-200-11		566																						977	1158
1GDC-200-12		614																						1025	1206
1GDC-200-21		606																						1017	1198
1GDC-200-22	318	654	133	65	140	18	69	65	140	18	69	200	19	400	350	19	8	5	450	396	430	355	779	1065	1246
1GDC-200-31		686																						1097	1278
1GDC-200-32		734																						1145	1326
1GDC-200-41		756																						1167	1348
1GDC-200-42		804																						1215	1396
1GDC-225-11		701																						1140	1605
1GDC-225-12		761																						1200	1665
1GDC-225-21	356	751	149	75	140	20	79.5	75	140	20	79.5	225	19	500	450	19	8	5	550	440	474	398	981	1190	1655
1GDC-225-22		811																						1250	1715
1GDC-225-31		811																						1350	1715
1GDC-225-32		871																						1310	1775
1GDC-250-11		715																						1225	1657
1GDC-250-12		775																						1285	1717
1GDC-250-21		765																						1275	1707
1GDC-250-22	406	825	168	85	170	22	90	75	140	20	79.5	250	24	600	550	24	8	6	660	490	524	432	1031	1335	1767
1GDC-250-31		825																						1335	1767
1GDC-250-32		885																						1395	1827
1GDC-250-41		895																						1405	1837
1GDC-250-42		955																						1465	1897
1GDC-280-11		762																						1375	1748
1GDC-280-12		852																						1405	1838
1GDC-280-21		822																						1375	1808
1GDC-280-22		912																						1465	1898
1GDC-280-31	457	892	190	95	170	25	100	85	170	22	90	280	24	600	550	24	8	6	660	550	584	462	1130	1445	1878
1GDC-280-32		982																						1535	1968
1GDC-280-41		972																						1525	1958
1GDC-280-42		1062																						1615	2048
1GDC-280-51		1062																						1615	2048
1GDC-280-52		1152																						1705	2138
1GDC-315-11		887																						1532	1897
1GDC-315-12		977																						1622	1987
1GDC-315-21		967																						1612	1977
1GDC-315-22	508	1057	216	100	210	28	106	95	170	25	100	315	28	740	680	24	8	6	800	620	654	497	1221	1702	2067
1GDC-315-31		1057																						1702	2067
1GDC-315-32		1147																						1792	2157
1GDC-315-41		1157																						1802	2067
1GDC-315-42		1247																						1892	2257



Technical data of 1GDC series

Frame reference and size	Rated power	Rated voltage	Full load speed in revolutions per minute	Speed with field weakened	Arm. current	Field power	Arm. circuit resistance	Arm. circuit resistance	Field inductance	Efficiency	Moment of inertia
Type	Power kW	us V	ns r/min	NF r/min	LN A	PF W	R (Ω (20°C))	LA mH	LF H	η (%)	GD ² kg*m ²
1GDC-250-41B	65	400	500	2000	200	3000	0.2115	2.8	7.02	80.7	7.0
1GDC-280-21B	100	400	600	3000	306	3500	0.1156	1.1	5.15	83.7	11.2
1GDC-280-41B	110	440	500	2000	295	4000	0.0124	1.6	3.88	38.8	14.4
1GDC-315-092	375	500	1750	1900	800	3700	0.0149	0.31	21.2	93.2	18.4
1GDC-315-12	444	460	1770	1800	1023	3850	0.0099	0.17	10.6	93.7	21.2
1GDC-315-21	150	500	500	1700	343	4350	0.0983	1.7	20.6	87	24
1GDC-315-22	230	220	705	1700	1177	4350	0.0105	0.21	1.91	88.3	24
1GDC-355-082	500	460	1470	1500	1157	4200	0.0101	0.17	8.56	83.2	37
1GDC-355-32	520	520	850	900	1075	6000	0.0159	0.36	7.37	92.4	52
1GDC-355-32	500	660	1000	1500	810	6000	0.0217	0.49	5.6	92.9	52
1GDC-355-42	567	520	825	900	1165	6500	0.0146	0.37	8.37	92.7	60
1GDC-400-12	600	500	1150	1600	1281	5200	0.0098	0.17	16.1	93.1	66
1GDC-400-22	400	520	660	1300	845	6000	0.0295	0.63	7.1	91.4	74
1GDC-400-32	618	550	850	900	1200	6400	0.0128	0.33	18.2	93	84
1GDC-400-42	400	520	500	1200	840	7100	0.026	0.77	10.4	92	94
1GDC-400-42	500	660	600	1200	824	7100	0.0344	0.89	7.73	91.1	94
1GDC-400-42	700	520	800	900	1445	7100	0.0115	0.29	14.8	92.4	94
1GDC-450-12	600	660	750	1000	980	5100	0.020	0.55	9.44	92.5	122
1GDC-450-21	326	660	500	1500	545	6500	0.0517	1.1	14.9	91.2	138
1GDC-450-22	400	520	400	900	860	6500	0.038	0.98	15	90	138
1GDC-450-22	500	520	500	1000	1000	6500	0.023	0.64	11.7	91.2	138
1GDC-450-22	600	520	600	1200	1250	6500	0.016	0.42	12	92.7	138
1GDC-450-22	700	600	750	1000	1240	6500	0.0133	0.38	8.75	93	138
1GDC-450-32	480	520	400	900	1030	7500	0.0305	0.77	10.6	90.1	156
1GDC-450-32	600	520	500	1000	1255	7500	0.0177	0.55	5.19	92	156
1GDC-450-32	700	520	600	1000	1460	7500	0.0134	0.33	8.22	92.3	156
1GDC-450-42	570	520	400	900	1220	7800	0.022	0.51	4.5	90.1	174
1GDC-450-42	700	520	500	1000	1450	7800	0.0142	0.44	7.6	92	174
1GDC-450-42	750	660	600	900	1215	7800	0.0181	0.58	9.37	92.5	174
1GDC-450-51	800	660	500	1000	1310	8600	0.0202	0.66	6.99	92	196





Address

VYBO ELECTRIC a. s. | tel: +421 944 105 361
Radlinského 18 | e-mail: mv@vyboelectric.eu
052 01 Spišská Nová Ves
Slovenská republika

www.vyboelectric.com



SOLUTIONS FOR INDUSTRY

BUREAU VERITAS
Certification



VYBO Electric a.s.
Radlinského 18, 052 01 Spišská Nová Ves
Slovak Republic

Bureau Veritas Certification Holding SAS – UK Branch certifies that the Management System of the above organisation has been audited and found to be in accordance with the requirements of the management system standards detailed below

ISO 14001: 2015

Scope of certification

MANUFACTURE AND SALE OF ELECTRIC MOTORS, SALES AND DEVELOPMENT OF VARIABLE FREQUENCY DRIVES.

Original cycle start date: 18.05.2022
Expiry date of previous cycle: N/A
Certification Audit date: 31.03.2022
Certification cycle start date: 18.05.2022

Subject to the continued satisfactory operation of the organization's Management System, this certificate expires on: 17.05.2025

Certificate No. SK-U22 055E Version: 1 Issue date: 18.05.2022

Certification body address: 5th Floor, 86 Prescott Street, London E1 8HQ, United Kingdom
Local office: Plynárska 7/B, BRATISLAVA 821 09, Slovak Republic



Further clarifications regarding the scope of this certificate and the applicability of the management system requirements may be obtained by consulting the organisation. To check this certificate validity please call: +421 2 2341 4165

Page 1 of 1



Bureau Veritas Certification

Certificate

Awarded to

VYBO Electric a.s.
Radlinského 18, 052 01 Spišská Nová Ves
Slovak Republic

BUREAU VERITAS CERTIFICATION (Z) s.r.o. certifies that the Management System of the above organisation has been assessed and found to be in accordance with the requirements of the management system standard detailed below

Standard

ISO 45001:2018

Scope of supply

MANUFACTURE AND SALE OF ELECTRIC MOTORS, SALES AND DEVELOPMENT OF VARIABLE FREQUENCY DRIVES.

Original Approval Date: 18-05-2022
Expiry date of previous cycle: N/A
Certification Cycle Start Date: 18-05-2022
Certification Cycle End Date: 17-05-2025
Subject to the continued satisfactory operation of the organisation's Management System, this certificate is valid until: 17-05-2025

To check this certificate validity please call: +420 210 090 215

Further clarifications regarding the scope of this certificate and the applicability of the management system requirements may be obtained by consulting the organisation.

Version 1 Issue Date: 18-05-2022
Certificate Number: CZF - 2206117

ISSUING OFFICE ADDRESS: BUREAU VERITAS CERTIFICATION CZ, s.r.o., Obchodní 1, 143 02 Praha 4, Czech Republic

1/1

ZERTIFIKAT ◆ CERTIFICATE ◆ 認證證書 ◆ CERTIFICADO ◆ CERTIFICAT



CERTIFICATE

TÜV SÜD Slovakia s.r.o.
Certification Body for Management Systems
Accredited by SNAS
Certificate on accreditation No. Q-011
certifies that



VYBO Electric a.s.
Radlinského 18
SK – 052 01 Spišská Nová Ves
ICO: 45 537 143

has established and applies
a Quality Management System for

**Manufacture and sale of electric motors.
Sales and development of variable frequency drives.**

An audit was performed, Report No. 2264/40/22/Q/AS/C
Proof has been furnished that the requirements
according to

STN EN ISO 9001:2016

are fulfilled. The certificate is valid from 2022-04-14 until 2025-04-13
Certificate Registration No. Q 2264-1

Bratislava, 2022-04-14

TÜV SÜD Slovakia s.r.o.
Certification Body for Management Systems
Member of Group TÜV SÜD
Jaskovka 6, 821 03 Bratislava

F-Q-019/26

Certificate SK22/3701

The management system of

VYBO Electric a.s.
Radlinského 18
052 01 Spišská Nová Ves, Slovakia

has been assessed and certified as meeting the requirements of

EN ISO 50001:2018

For the following activities

**Production & sales of electric motors.
Sales & development of variable frequency drives.**

Further clarifications regarding the scope of this certificate and the applicability of EN ISO 50001:2018 requirements may be obtained by consulting the organisation.

This certificate is valid from 7 April 2022 until 6 April 2025
and remains valid subject to satisfactory surveillance audits.
Recertification audit due a minimum of 60 days
before the expiration date.
Issue 1. Certified with SGS since 7 April 2022

Authorised by

Ing. Róbert Bodnár
Director
SGS Slovakia spol. s r. o.
Kýzucká 14, 040 11 Košice, Slovakia
t +421 55 783 61 11, f +421 55 783 61 20, www.sgs.com

Page 1 of 1



This document is issued by the Company subject to its General Conditions of Certification. Services accessible at www.sgs.com and conditions. Attention is drawn to the limitations of liability, indemnification and jurisdictional issues established therein. The authenticity of this document may be verified at <http://www.sgs.com/certificates/certificate>. Any unauthorised alteration, forgery or falsification of the content or appearance of this document is unlawful and offences may be prosecuted to the fullest extent of the law.